

Nebulizers

Introduction to Glass Expansion Nebulizers	1
Nebulizer Types	1
Glass Expansion Nebulizer Part Numbers Explained	1
Learn about Glass Expansion Nebulizers	2
Nebulizer Selection Guide	3

Spray Chambers

Introduction to Glass Expansion Spray Chamber	4
Spray Chamber Types	4
Helix CT - Interface Between Nebulizer and Spray Chamber	4
HydraMist Simultaneous Cold Vapor/Pneumatic Nebulization Spray Chamber	5
Spray Chamber Selection Guide	6

Torches

RF Coils and ICP-MS Cones	8
---------------------------------	---

Accessories

IsoMist XR Programmable Temperature Spray Chambers	9
Guardian In-Line Particle Filter	10
Guardian In-Line Non-Return Gas Filter	10
Eluo Nebulizer Cleaning Tool	11
Trident CT In-Line Reagent Additions Kit	11
Elegra Argon Humidifier	12
Single-Cell Sample Introduction System for ICP-MS	12
Laser Ablation	13
Autosampler Probes	14

Agilent Technologies®

7900	ICP-MS	15
8900	ICP-MS	18
7800/7850	ICP-MS	21
7700/8800	ICP-MS	24
5800/5900 SVDV/VDV/RV	ICP-OES	27
5100/5110 SVDV/VDV/RV	ICP-OES	27
700-ES Axial	ICP-OES	29
700-ES Radial	ICP-OES	32

PerkinElmer®

NexION 1000/2000	ICP-MS	35
NexION 300/350	ICP-MS	37
Avio 200/500	ICP-OES	40
Optima 8000/8300 DV	ICP-OES	42
Optima 4000/5000/7000 DV	ICP-OES	44
Optima 4000/5000/7000 V	ICP-OES	46

Shimadzu®

2030	ICP-MS	48
9000/9800 and 7500/8100	ICP-OES	50

Spectro™

Arcos II EOP/ Blue EOP/TI & Green TI	ICP-OES	53
Arcos II SOP/ Blue SOP & Green SOP/DSOI	ICP-OES	55

Thermo Fisher®

Q/RQ/TQ	ICP-MS	57
PRO Duo	ICP-OES	59
PRO Radial	ICP-OES	61
6000/7000 Duo	ICP-OES	63
6000/7000 Radial	ICP-OES	65

Fittings and Connectors

Nebulizer Fittings and Connectors	67
Spray Chamber/Torches Fittings and Connectors	68

Pump Tubing

Standard Peristaltic Pump Tubing	69
Contour Flared End Peristaltic Pump Tubing	72

Introduction to Glass Expansion Nebulizers

The nebulizer is a critical component of your ICP sample introduction system, so why not opt for the highest quality? Glass Expansion has been manufacturing ICP nebulizers since the early 1980s and continually updates nebulizer designs to improve performance and ease of use. Our proprietary designs include a thick walled VitriCone capillary, UniFit sample line connector and the Direct Connect (DC) product line.

Whether your ICP laboratory is analyzing clean aqueous samples, samples containing HF and/or high dissolved salts, or volatile organic solvents; Glass Expansion has a nebulizer to suit your needs. Learn about the performance advantages and overall difference in construction quality that a Glass Expansion nebulizer can provide your ICP laboratory.

Nebulizer Types

Nebulizer	TDS (%)	Particulates (µm)	HF	Precision	Purity	Material
SeaSpray MicroMist Conikal Slurry Quartz SeaSpray	20 15 5 1 20	75 40* 75 150 75	No No No No No	High High High High High	Good Good Good Good Excellent	Glass Glass Glass Glass Quartz
OpalMist	15	75*	Yes	High	Excellent	PFA
DuraMist	30	75*	Yes	High	Good	PEEK
VeeSpray	30	300	Yes	Moderate	Good	Ceramic

* Varies with nebulizer uptake

Glass Expansion Nebulizer Part Numbers Explained

Glass DC Nebulizers

Conikal

1mL/min uptake

A13-07-UC1



A#-yy-**ZZ**nnn

- A** Gas pressure rating of 40 psi
- #** Gasline fitting type eg:
13 = Suitable for Agilent® 5100/5110/5800/5900
- yy** The argon flow in L/min eg. 07=0.7L/min
- ZZ** Nebulizer model type:
UC = Conikal U-Series nebulizer
US = Slurry U-Series nebulizer
USS = SeaSpray U-Series nebulizer
UM = MicroMist U-Series nebulizer
CV = Ceramic VeeSpray v-groove nebulizer
DM = DuraMist HF resistant nebulizer
PFA = OpalMist PFA HF resistant nebulizer
- nnn** Aspirated uptake at nominal argon flow, in mL/min eg:
UC1 = 1mL/min
UM04 = 0.4mL/min
PFA005 = 0.05mL/min

Learn About Glass Expansion Nebulizers

All Glass Expansion concentric nebulizers use the unique VitriCone™ construction delivering the best possible precision.

DC Nebulizer



The DC (Direct Connection) nebulizer has a UniFit sample connector which slides easily over the sample arm and an argon connector configured to connect directly to your ICP.

DC Nebulizer Benefits:

- Inert metal-free argon connector.
- Instrument-specific Direct Connect flexible argon line.
- Reliable ratchet fitting ensures leak-free gas connection.

DC versions of the SeaSpray, MicroMist, Conikal, Slurry, DuraMist, OpalMist and VeeSpray nebulizers are available to suit the most common models of ICP-OES and ICP-MS.

The DC nebulizer part number has a prefix specific to each type of gas connector. For example, the prefix "A13-" denotes a connector for the Agilent® 5100/5110/5800/5900 ICP-OES, so part number A13-07-USS2 is a SeaSpray nebulizer configured for direct connection to the Agilent® 5100/5110/5800/5900.

In addition to these unique benefits, the DC nebulizer shares the following benefits with the U-Series nebulizer:

- Resists blockage: The sample channel is uniform from the entry point to the tip, so there is nowhere for particulates to be trapped.
- Fast washout: Since there is nowhere for sample to be trapped, the fastest possible washout and highest sample throughput is achieved.
- Simple to use: Our proprietary UniFit connector slides easily over the sample arm and creates an excellent seal.
- Full length VitriCone construction: With the VitriCone design, the sample channel is constructed from heavy glass capillary which is machined to very high tolerances.



DC Nebulizer Gas Fitting Connectors

Agilent® Vista/700-ES, 4100/4200	70-803-0969
Agilent® 4500/7500	70-803-1086
Agilent® 7700/7800/7900/8800/8900	70-803-1105
Agilent® 5100/5110/5800/5900	70-803-1105
Analytik Jena® ICP-MS	70-803-0969
Analytik Jena® ICP-OES	70-803-1105
Horiba® Jobin Yvon (All models)	70-803-1105
Leeman (All Models)	70-803-0969
Nu Instruments ICP-MS	70-803-1858
PerkinElmer® ICP-OES	70-803-1070
PerkinElmer® Elan/NexION 300/350	70-803-1049
PerkinElmer® NexION 1000/2000/5000	70-803-1449
Shimadzu® (All models)	70-803-1311
Spectro™ (All models)	70-803-1070
Thermo® PRO, 6000/7000, Q/RQ/TQ & X-Series	70-803-1292
Thermo® Neptune	70-803-1468

U-Series Glass Concentric Nebulizers

SeaSpray, MicroMist, Conikal and Slurry U-Series nebulizers are available to suit all common models of ICP-OES and ICP-MS. Each U-Series nebulizer is supplied with a UniFit sample connector.

U-Series nebulizers can be identified by the letter 'U' in the part number, eg. ARG-07-USS2 or ARG-1-UM04.



All glass concentric nebulizers in this catalog are U-Series nebulizers.

U-Series Quartz Concentric Nebulizers

The Quartz SeaSpray concentric nebulizer is made from ultra pure quartz and offers outstanding nebulization efficiency for trace level analyses. It offers freedom from clogging while nebulizing solutions to the limit of solubility of most mineral salts, and conferring significant sensitivity gains. It is specifically designed for ultra trace level analysis.





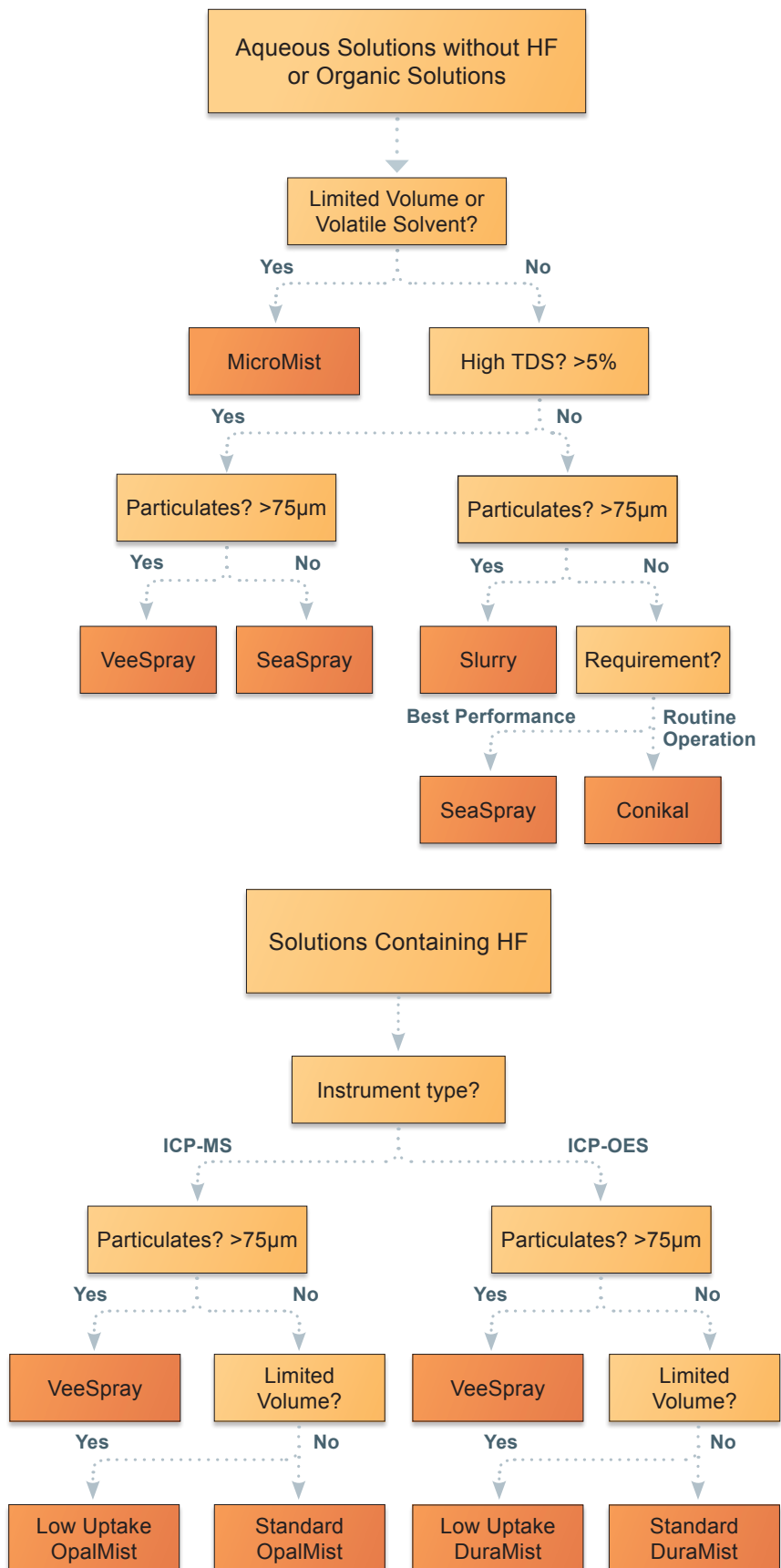



Nebulizer Selection Guide



Introduction to Glass Expansion Spray Chambers

The spray chamber is a crucial component of the ICP sample introduction system since it has a profound effect on transport efficiency, precision, and washout. Glass Expansion revolutionized the spray chamber design for the ICP industry with the Tracey and Twister cyclonic spray chamber, providing improved efficiency and reduced washout. Glass Expansion's unique Helix CT nebulizer interface, provides a zero dead volume seal that results in higher throughput compared to non-Glass Expansion designs.

Spray Chamber Types

Tracey		Internal Volume, mL: 50 Internal Baffle: No HF-resistant: No Precision: Very Good Purity: Good Material: Glass
Twister		Internal Volume, mL: 50 Internal Baffle: Yes HF-resistant: No Precision: Excellent Purity: Good Material: Glass
Cinnabar		Internal Volume, mL: 20 Internal Baffle: No HF-resistant: No Precision: Very Good Purity: Good Material: Glass
Twinnabar		Internal Volume, mL: 20 Internal Baffle: Yes HF-resistant: No Precision: Very Good Purity: Good Material: Glass
Tracey TFE		Internal Volume, mL: 50 Internal Baffle: No HF-resistant: Yes Precision: Good Purity: Good Material: PTFE
Twister TFE		Internal Volume, mL: 50 Internal Baffle: Yes HF-resistant: Yes Precision: Very Good Purity: Good Material: PTFE
Tracey PFA44		Internal Volume, mL: 44 Internal Baffle: No HF-resistant: Yes Precision: Good Purity: Excellent Material: PFA

Helix CT - The Modern Interface Between Nebulizer and Spray Chamber



Traditionally, ICP-OES and ICP-MS sample introduction systems have relied on o-rings to form a gas-tight seal between the nebulizer and spray chamber. There are several drawbacks with an o-ring seal, such as:

- Potential for contamination due to dead volume around the o-ring seal
- Chemical resistivity of strong acids and organic solvents
- The o-rings are difficult to replace, often requiring tools
- Bonding to the nebulizer can result in breakage

Glass Expansion Helix CT spray chamber with ConstantTorque technology, provides a constant, reproducible, inert, gas-tight seal between the nebulizer and spray chamber.

The main feature of the Helix CT spray chamber is the Helix locking screw with built-in torque control mechanism that allows for a consistent seal of the PTFE ferrule against the nebulizer –making it impossible to overtighten or undertighten while ensuring a gas-tight seal each and every time.

A PressFit PTFE ferrule provides a chemically inert seal around the nebulizer, which is immune to strong acids and organic solvents routinely used in ICP sample preparation.

The Helix CT cyclonic spray chamber by Glass Expansion, therefore, eliminates all the drawbacks of the o-ring nebulizer seal, while improving user safety by preventing broken nebulizers.

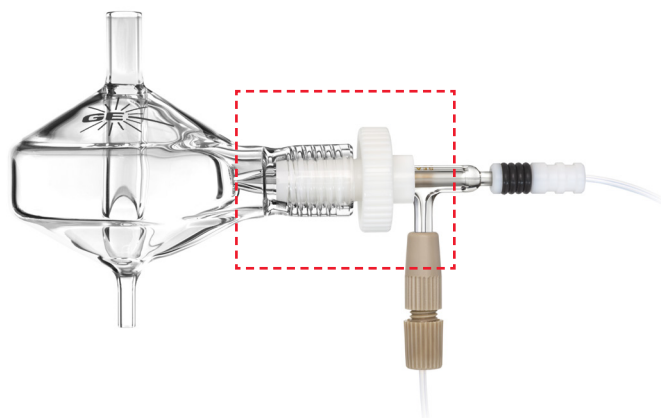

HydraMist Simultaneous Cold Vapor/ Pneumatic Nebulization Spray Chamber

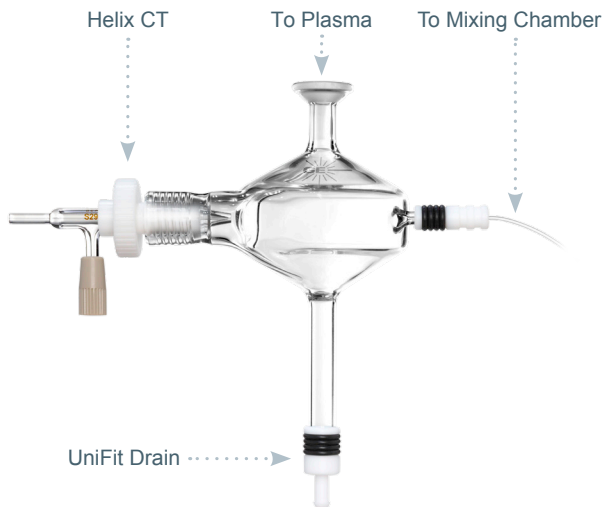

* Note: Nebulizer is not included in HydraMist Kit.

The Glass Expansion HydraMist is a sensitive, simple-to-use spray chamber for Inductively Coupled Plasma (ICP) that allows simultaneous operation of both conventional pneumatic nebulization and cold-vapor/hydride generation. Cold vapor generation can provide more than 10-fold improvement in sensitivity on ICP for cold vapor forming elements such as As, Sb, Se, Tl and Hg. The generation of volatile species of these elements results in increased analyte loading of the analytical plasma giving lower detection limits.

The design of the HydraMist spray chamber is based upon Glass Expansion's industry-standard cyclonic spray chamber, giving excellent sensitivity and short-term analytical precision with fast washout. The HydraMist spray chamber features a secondary inlet port that mixes the aerosolized sample and liquid reductant inside the spray chamber for rapid conversion of the As, Sb, Se, Tl and Hg analytes into volatile hydride species. The unique drain design ensures fast, complete removal of waste from the spray chamber, eliminating excess hydrogen build-up that causes sample reflux degrading analytical precision.

The HydraMist Spray Chamber Features:

- The same outstanding short-term analytical precision and washout as other Glass Expansion cyclonic spray chambers
- Fast and complete vapor phase formation of volatile As, Se, Sb, Tl and Hg species for the best detection limits in hydride generation mode
- A unique drain design to eliminate hydrogen build-up and sample reflux that degrades short-term precision
- Economic, just replace your current spray chamber and keep your existing nebulizer
- Improve productivity by analysing non-hydride forming elements and cold vapor elements simultaneously, avoiding system shutdowns to change over between the hydride generator accessory and conventional pneumatic nebulization

HydraMist Kit

Agilent® 5100/5110/5800/5900	KT-1157
Agilent® 7700/7800/7900/8900	KT-1168
Analytik Jena® PQ 9000	KT-1157
PerkinElmer® Avio 200/500	KT-1157
PerkinElmer® Optima 8000/8300 DV	KT-1162
PerkinElmer® Optima 4000/5000/7000 DV	KT-1162
Shimadzu® ICPE 9000/9800	KT-1157
Spectro™ Arcos II SOP/EOP and Blue EOP/SOP	KT-1160
Thermo® PRO	KT-1160
Thermo® Duo 7600	KT-1156
Thermo® Duo 6000/7200/7400	KT-1179

Spray Chamber Selection Guide

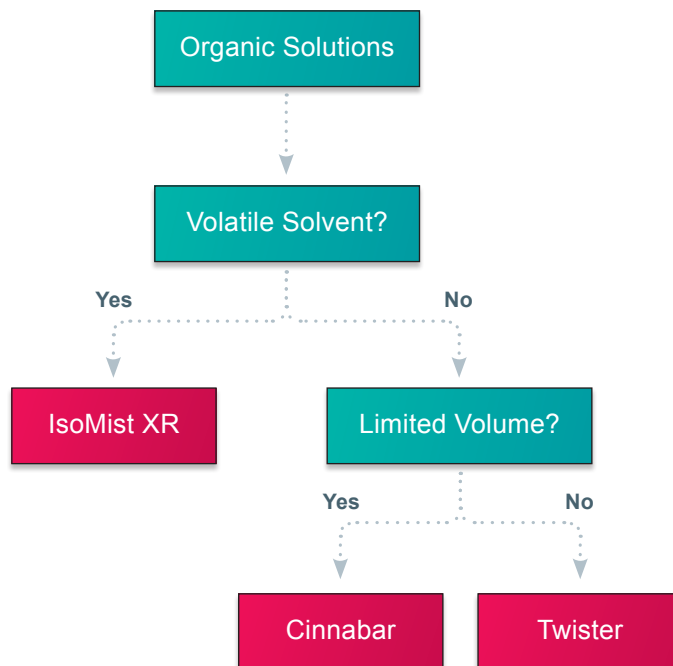
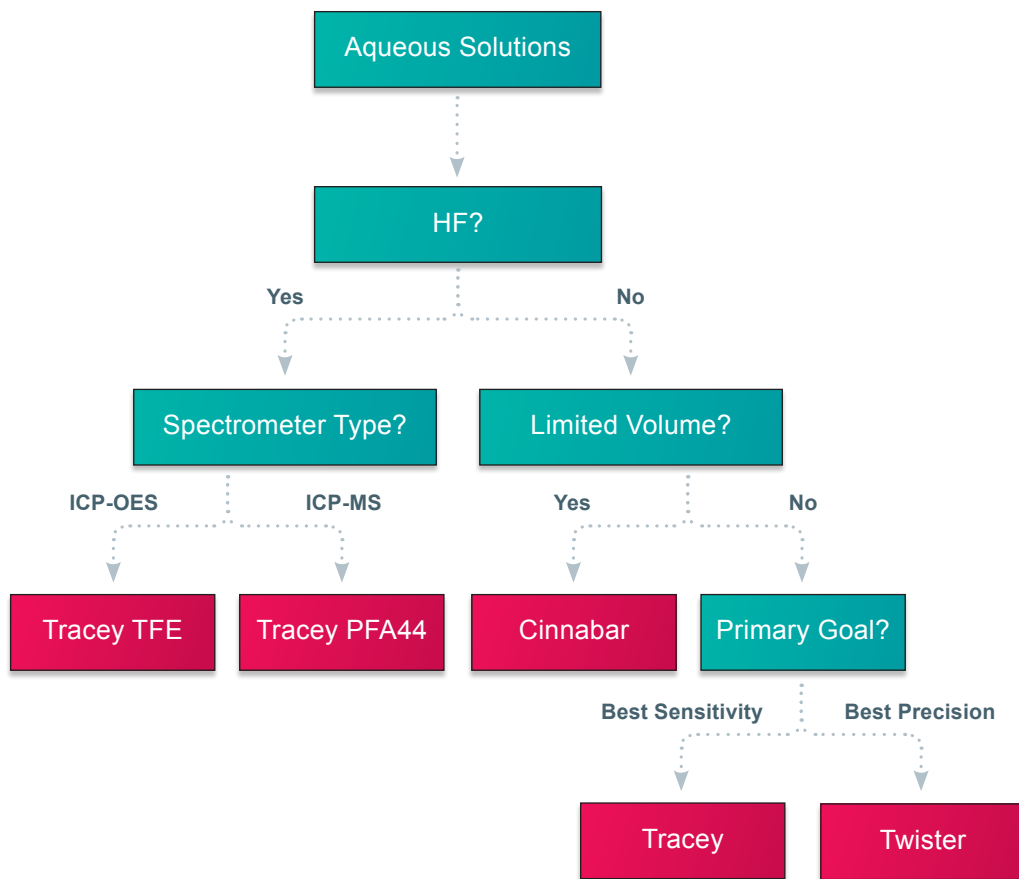

D-Torch (Demountable Torch)

The D-Torch is a revolutionary new demountable torch design. It provides the benefits of a fully demountable torch at a significantly lower cost. Interchangeable outer tubes made of quartz or ceramic are available. The quartz tube is ideal for most aqueous applications and, since the outer tube is usually the first to wear, you can make a significant saving by replacing just the outer tube rather than the whole torch.

The ceramic outer tube is of particular benefit for the analysis of samples with high salt content or wear metals in engine oils, where quartz outer tubes often suffer from short lifetime. The ceramic outer tube has a much longer lifetime, greatly reducing interruptions and downtime due to torch failure. The D-Torch uses the same mounting system as the standard fixed torch so there is no additional cost or complexity to install it.

- Demountable outer tube – why replace the entire torch when just the outer tube wears?
- Interchangeable quartz and ceramic outer tubes.
- Much lower cost than other demountable torches.
- Interchangeable injectors for aqueous, organics, high dissolved solids or HF applications.

* The D-Torch is covered by US Patent 8,232,500 B2

The D-Torch models suited for the Agilent® 5100/5110/5800/5900, PerkinElmer® Avio 200/500, Thermo® PRO and Spectro™ Arcos II and Blue incorporate the same easy to use, self-aligning and locking features of the standard torch in a robust cost effective design.

Complete D-Torch



Injectors



Outer Tubes

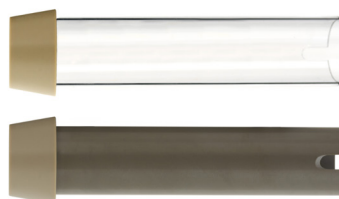

Torch Body



Semi Demountable Torch



- Highly accurate construction
- Lower running cost than one-piece torches

Usually comprises a quartz torch body, a torch adaptor, an injector and GazFit connectors. All these parts are replaceable, making the semi demountable torch more cost effective than the fixed quartz torch. The design of the torch for standard analyses and HF analyses is the same, with only the injector material changing. For aqueous and organics analyses use a quartz injector, while for HF analyses use an alumina injector. Hence simply interchange between quartz and alumina injectors for appropriate analyses. Several internal diameters for both quartz and alumina injectors are also available.

Fixed Quartz Torches (One Piece)



- Precise quartz construction
- Wide range held in stock
- Simple to use
- Lowest initial cost

RF Coils – more efficient energy transfer



Why Change your RF Coil?

- Regular replacement of corroded coils reduces the load on the RF generating system.
- Changing corroded coils increases energy transfer, resulting in a more robust plasma and generally higher analytical line intensities.

Advantages of Glass Expansion RF Coils

- High quality and consistent plating of our coils promotes extended coil life.
- Each coil is supplied on a plastic former ensuring correct dimensions and easier installation.
- Each coil is supplied in a special protective container to ensure correct dimensions are maintained, and the coil arrives corrosion free.
- Correct alignment of the RF Coil with respect to the torch body reduces devitrification of the outer tube.
- Reusable alignment tools ensure correct installation every time. Our Do-it-yourself instructions saves time.

Glass Expansion installation Kits for RF Coils

- Incorrect alignment of the torch in the coil will dramatically reduce torch life. The Glass Expansion Installation Kits help ensure correct alignment and maximum torch life.
- Correct alignment of the RF Coil with respect to the torch body reduces devitrification of the outer tube.
- Re-usable alignment tools are available separately to ensure correct installation of the coil every time.
- Our easy to follow Do-It-Yourself installation instructions save you time, and the cost of a service call.

All kits contain:

- An Installation Kit – Aligns coil to torch mounting bracket.
- Required Spanner/s – Designed specifically for each instrument.
- USB - Do-It-Yourself instructions.



ICP-MS Cones

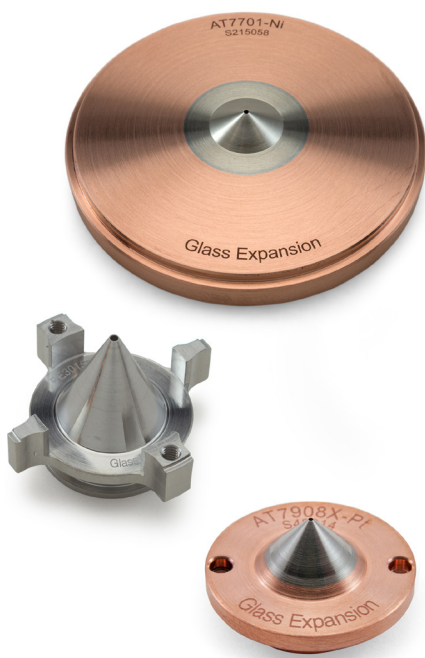

Our ICP-MS interface cones are made from ultra-pure metals sourced from specialty smelters. Our highly experienced machinists use state of the art CNC machines and electron beam welding to provide cones with the finest tolerances for the highest quality.

We supply cones for all of the popular ICP-MS models and, to make sure you get all the support you need, we have a staff of technical experts and a fully equipped ICP-MS laboratory for testing and evaluation.

No-risk guarantee:

As with all of our products, our cones are backed by our complete satisfaction guarantee.

Free refurbishment:

Extend the life of your platinum cones with our free refurbishment program. In many cases, a platinum cone can be refurbished multiple times and its lifetime greatly extended. As a customer service, Glass Expansion will refurbish your platinum cones free-of-charge.

Platinum reclaim:

If your platinum cone cannot be refurbished, we will provide a rebate for the value of platinum in the cone.

Coneguard

The ConeGuard Thread Protector protects the cone thread from corrosive cleaning solutions and greatly extends cone life.

IsoMist XR Programmable Temperature Spray Chamber



The IsoMist XR programmable temperature controlled cyclonic spray chamber now features an improved thermodynamic design providing an extended temperature range and faster cool-down, so your ICP is ready to go sooner.

IsoMist XR is a compact, convenient and maintenance-free temperature controlled sample introduction system for all ICP's.

Improved Analytical Stability with Precise Temperature Control

On the IsoMist XR, the spray chamber temperature is accurately controlled through an improved thermodynamic design using a multi-stage peltier device. The spray chamber temperature is settable in 1°C increments from -25°C to 80°C guaranteeing optimum conditions can be used for any application.

Reduce Oxide Interferences in ICP-MS

Using the IsoMist XR spray chamber at sub-ambient temperatures on an ICP-MS, the sample is cooled, less water vapor is transferred to the plasma resulting in lower oxide formation and reduced polyatomic (ArO, ArOH) interferences. Less oxides in the plasma mean fewer interferences, improving accuracy and detection limits.

Perfect for Naphtha and Gasoline Analysis

For volatile solvents, a lower sample introduction temperature reduces nebulization efficiency avoiding quenching of the plasma from solvent overloading. With a minimum operating temperature of -25°C, analyzing volatile organic solvents such as naphtha and gasoline by ICP is even easier.

Improve Analytical Stability with Constant Spray Chamber Temperature

Fluctuations in the lab temperature affects sample viscosity and nebulization efficiency. Maintaining the sample introduction system at a constant and stable temperature improves analytical reproducibility, enhances throughput and lowers operating costs by reducing the need to re-run samples when a check standard drifts outside the acceptable upper or lower limits.

Elevated Sample Introduction Temperatures Enhances Sensitivity

The sensitivity for many analyses can be enhanced by operating the spray chamber at elevated temperatures - especially important for limited sample volumes. Heating the spray chamber also helps with the analysis of viscous samples such as lubricants and edible oils.

A Spray Chamber Optimized for Analytical Performance

The IsoMist XR incorporates a proven cyclonic spray chamber design in glass, quartz and HF resistant PFA with Helix CT interface. Compared to a Scott type spray chamber, cyclonic spray chambers are more sensitive and have better washout. The IsoMist XR includes the Helix CT nebulizer interface, which eliminates sample contamination and ensures easy nebulizer removal for routine nebulizer cleaning. The Helix CT nebulizer interface also has zero dead volume, reducing carry-over and improving washout between samples. With a positive stop built-in, Helix CT ensures correct and reproducible nebulizer insertion depth for constant nebulizer performance.



Easy to Use Software

For maximum convenience, the IsoMist XR can be controlled from a PC via USB or Bluetooth wireless interface. The spray chamber temperature can be monitored during an analytical run with time vs temperature plot on your PC screen.

Elegant, Ergonomic and Compact

The IsoMist XR is an elegant, compact, stand-alone system manufactured from materials resistant to attack from acids and solvents commonly used in ICP analysis. By using a peltier to maintain the spray chamber temperature, the messy, noisy and high-maintenance refrigerated circulating baths used with jacketed spray chambers has been eliminated. The compact design means all IsoMist XR Programmable Temperature Controlled Spray Chambers are compatible with virtually any ICP-OES or ICP-MS.

Guardian In-Line Sample Filter



If there are particulates in your samples, there is a risk that they may get trapped in the narrow bore sample tubing or within the nebulizer. The Guardian In-Line Sample Filter provides a simple and effective way to eliminate this risk. This filter is easily inserted in the sample tubing between the autosampler probe and the nebulizer. It incorporates a 120 micron PolyComb filter and is suitable for use with 1/16 inch (1.6mm) OD or 1.3mm OD sample tubing.

The purpose-built clog-resistant design is ideal for ICP samples. Unlike sintered or frit style filters, the linear honeycomb structure makes the PolyComb filter resistant to clogging from particulates. Any particle build-up is easily removed by back-flushing using the Eluo Adaptor 70-803-1160. And the PEEK material is suitable for use with all of the most common ICP solutions.



Eluo Adapter For In-Line Filter

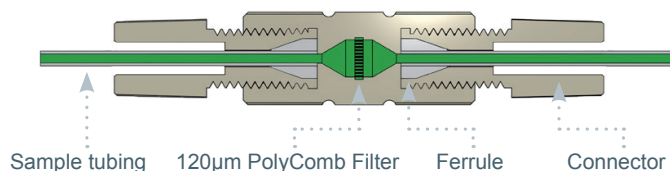

Guardian In-Line Sample Filter

In-Line Filter	70-803-1108
Eluo Adaptor for In-Line Filter	70-803-1160
Fitting Seal 1/16 (PKT 10)	70-803-0749
Fitting Seal 1.3mm (PKT 10)	70-803-0748

Guardian In-Line Non-Return Gas Filter



The new Guardian In-line Non-Return Gas Filter provides protection for your ICP system in two ways:

1. A non-return valve prevents acidified sample or rinse solution syphoning into the instrument gas box.
2. 30µm PolyComb filter protects the nebulizer from particulates in the instrument gas supply.

The Guardian In-line Non-Return Gas Filter is positioned between the Argon inlet on the Direct Connection nebulizer and the gas supply fitting on the instrument. The In-line Non-Return Filter has a one-way valve that allows argon to flow from the instrument into the nebulizer, but prevents liquid syphoning into the instrument. A unique PolyComb 30µm filter design protects the nebulizer from particulates from the gas supply or from worn or damaged fittings in the gas lines. Unlike Sintered or Frit style filters, the linear honeycomb structure makes PolyComb most resistant to particulate and dissolved solid clogging.

Syphoning of the sample or rinse solution into the nebulizer argon control module on your ICP can occur at the end of an analytical run when the nebulizer gas pressure is turned off and there is liquid in the sample flow path. It is made worse if the autosampler probe stays in the rinse position at the end of a run.

A real problem using an autosampler for unattended overnight runs, it is a silent, invisible killer of your ICP. Acidified solution in the instrument Argon control module can cause corrosion to electronic sensors in mass flow controllers and damage regulators that can result in expensive repairs to your ICP and un-planned down time.

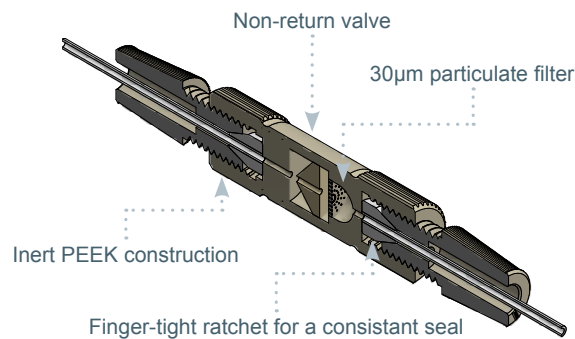

Guardian In-Line Non-Return Gas Filter

Guardian DC In-Line Non-Return Gas Filter	70-803-1942
Guardian In-Line Non-Return Gas Filter	70-803-1362

Eluo Nebulizer Cleaning Tool

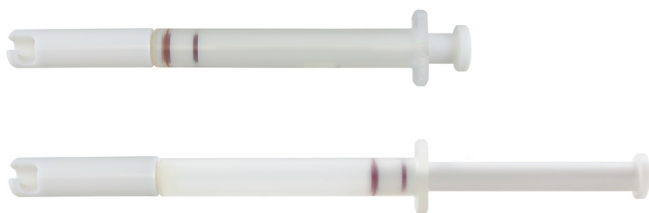

Cleaning your nebulizer is as easy as 1, 2, 3.

1. Fill your Eluo with Methanol.
2. Insert your nebulizer, tip first, into the Eluo.
3. Clean your nebulizer by pressing the Plunger down.

Particle build-up in a nebulizer capillary and tip causes sample flow to be constricted, reducing nebulizer efficiency and performance. Now, blocked nebulizers can be safely and easily restored to optimum performance with a revolutionary cleaning instrument – the Eluo.

The Eluo is designed to efficiently deliver a cleanser through the nebulizer capillary to dislodge particle build-up and thoroughly clean the nebulizer. One simple action does it all. No more messy procedures or shattered nebulizers in ultrasonic baths. Use the Eluo regularly to maintain nebulizer performance and prolong nebulizer life. Every lab should have an Eluo.

The Eluo can also be conveniently used to clean the Inline Particle Filter P/N 70-803-1108 with the addition of Adaptor P/N 70-803-1160.

Eluo Nebulizer Cleaning Tool

Eluo for Glass concentric Nebulizers	70-ELUO
Eluo HF Nebulizer Cleaner	70-ELUO-OPD
Fluka RBS-25 concentrate	FLUKA25
O-ring Kit for Eluo (2 sets)	70-0806

Trident CT™ In-Line Reagent Additions Kits

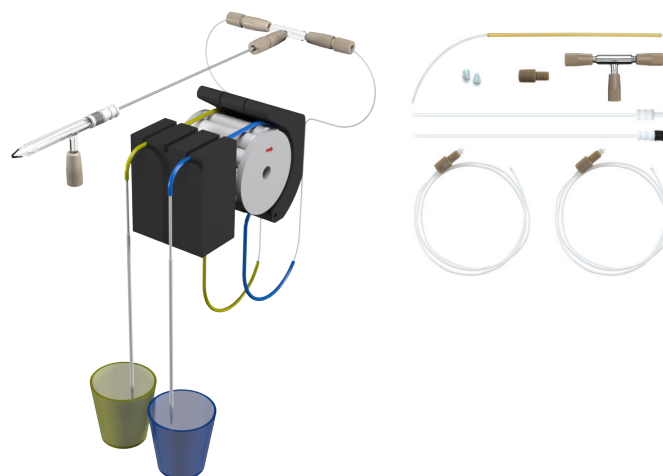

Internal standards are often used in ICP Spectrometry to improve stability. The internal standardization process involves the addition of a known concentration of a particular element to every sample and can be a very time-consuming procedure. The Glass Expansion Trident Kits allow the internal standard to be automatically mixed with each sample during sample introduction, saving considerable sample preparation time.

The Trident CT™ mixing chamber is based on the industry-proven design of the Trident, but with the addition of Glass Expansion's ConstantTorque™ (CT) to provide a simple-to-use, leak-free connection for both the internal standard and sample, every time.

The heart of the kit is the mixing chamber, designed with zero dead volume CT fittings. With other mixing chambers, worn or improperly fitted connections leak, inject a stream of air bubbles into the nebulizer flow, degrading short-term analytical precision (%RSD). By using CT ratchet-style fittings, the Trident CT eliminates air leaks, optimizing analytical performance.

The Trident CT features:

- Compact, efficient mixing chamber ensures complete mixing of the sample and reagent.
- CT fittings for a durable, leak-free seal on all connections.
- Zero dead volume connections.
- Completely modular so that damaged or lost components can easily be replaced.

Check the Trident Dilution Factor Calculator on our website to find out the sample and internal standard dilution factors for selected combinations of pump tubing.

The peristaltic pump tubing is not supplied as part of the Internal Standard Kit but can be ordered separately.

In-Line Reagent Additions Kits

Trident CT In-Line Reagent Additions Kit	60-703-1179
Trident Internal Standard Kit for HF (original design)	60-808-1150

Elegra Argon Humidifier



Elegra

Elegra Dual

An Argon Humidifier is commonly used in ICP analyses involving samples with high concentrations of dissolved solids. It helps to alleviate salt deposits in the nebulizer and torch injector, allowing uninterrupted and maintenance-free operation.

- Compact, cost-effective design.
- No heating or electric power required.
- Non-pressurized water reservoir.
- An easy-to-use bypass switch allows you to take the Elegra off-line without disconnecting argon lines. (Not available with Elegra Dual)
- Highly efficient membrane humidification technology.
- Improved signal stability for samples with high TDS.
- Simple to install, use and maintain.
- Improves productivity by reducing down-time for cleaning.
- Inert metal-free construction eliminates contamination.
- Maximum and minimum fill marks ensure that you are always operating under optimum conditions.
- Compatible with all ICP-OES and ICP-MS models. Direct connection to argon outlet provided for most models.
- Elegra Dual two-channel configuration available for ICP-MS instruments using auxiliary argon.

Elegra Argon Humidifier

O-ring for Capricorn or Elegra Cap (PKT 3)	70-V-225
Elegra Stand	70-803-1581

High Sensitivity Single-Cell Sample Introduction System for ICP-MS



Single-cell analysis using an Inductively Coupled Plasma-Mass Spectrometer (SC-ICP-MS) is enhancing the fundamental understanding in cellular biology, oncology and drug discovery. SC-ICP-MS provides for the quantification of metals in individual biological cells and is used as a research tool to allow scientists to study disease aetiology, better understand diseased cell states and develop new drug treatments to give better patient outcomes.

In single-cell analysis, the sample introduction system converts a continuous stream of biological cells efficiently into an aerosol of individual cells and transfers the aerosol into the Inductively Coupled Plasma of the ICP-MS for analysis. A critical aspect of the sample introduction system is the cells must remain intact and unruptured during the nebulization process to ensure each individual cell produces a single ion burst inside the plasma that can be transferred into the mass analyser of the ICP-MS for quantification.

Conventional ICP-MS spray chambers have low transport efficiencies (typically < 5% TE) that filter out larger droplets (> 5µm) from the nebulizer aerosol. As most cell lines of interest are larger than 5µm, the secondary filtering mechanism of conventional spray chamber designs rejects a high proportion of the cells from passing to the plasma. To overcome this significant deficiency the Glass Expansion spray chamber design for single cell analysis is different from conventional ICP-MS spray chambers.

Glass Expansion have developed a high sensitivity Single-Cell Sample Introduction system which consists of:

- High efficiency, low uptake, concentric glass nebulizer designed to efficiently nebulize single-cell suspensions without compromising cell integrity
- Low volume, on-axis, laminar-flow spray chamber directly coupled to the ICP for the highest transport efficiency of the nebulized single-cell
- Patent pending MicroJet gas adapter which entrains and shapes the aerosol plume to reduce cell deposition onto the spray chamber walls and increase sample transport efficiency suspension

Single-Cell Sample Introduction System

For Agilent® ICP-MS	KT-1155
For Thermo® ICP-MS	KT-1172
For TOFWERK icpTOF	KT-1172
For NexION 1000/2000/5000	KT-1184
For PerkinElmer® NexION 300/350	KT-1204
For NU ATTOM	KT-1205

Laser Ablation

P/N: 21-809-4309



P/N: 70-803-1600



P/N: 31-808-4034



P/N: 20-809-4550



P/N: 21-809-2801



P/N: 31-808-3863
OD: 4mm
ID: 2mm



S13 (13 mm) cup Adaptors

P/N: 31-800-1007
ID: 4mm



P/N: 21-809-4140



P/N: 21-809-0965C
OD: 6mm
ID: 4mm



P/N: 31-808-3045
OD: 4mm
ID: 2mm



GazFit Connectors



GazFit Union Connectors (for rigid walled tubing)

GazFit Union 4mm (PKT.2)	GAZ-04U
GazFit Union 6mm (PKT.2)	GAZ-06U
GazFit Union 8mm (PKT.2)	GAZ-08U



Standard GazFit Connectors (for soft walled tubing)

GazFit Connectors for 4mm OD side arm (PKT.4)	GAZ-04
GazFit Connectors for 5mm OD side arm (PKT.4)	GAZ-05
GazFit Connectors for 6mm OD side arm (PKT.4)	GAZ-06
GazFit Connectors for 8mm OD arm (PKT.2)	GAZ-08
GazFit Connectors, 2 for 6mm OD side arms, 2 for 4mm OD side arms (PKT.4)	GAZ-0604
GazFit Connectors for 6mm OD side arm with connection for 1/8inch ID tubing (PKT.4)	GAZ-06-1/8

Autosampler Probes

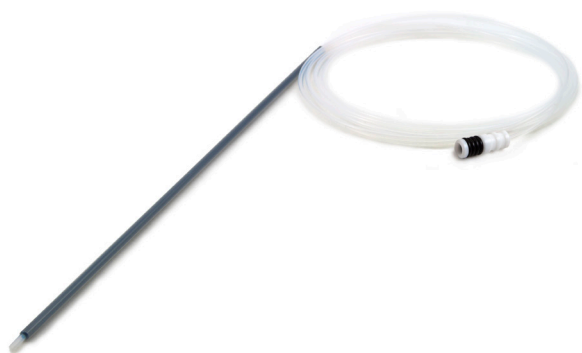

For Cetac 260, 280, 520, 520HS, 560, 860 and XLR8

PTFE Encapsulated Carbon Fibre Probe 0.25mm ID with EzyFit	70-803-1088
Polyimide sheathed Autosampler Probe 0.5mm ID	60-808-1186L
PTFE Encapsulated Carbon Fibre Probe 0.25mm ID	70-803-1523
PTFE Encapsulated Carbon Fibre Probe 0.5mm ID	70-803-0784
PTFE Encapsulated Carbon Fibre Probe 0.5mm ID with UniFit	70-803-1380
PTFE Encapsulated Carbon Fibre Probe 0.75mm ID with ratchet fitting	70-803-1443
PTFE Encapsulated Carbon Fibre Probe 0.75mm ID	70-803-1880
PTFE Encapsulated Carbon Fibre Probe 1.0mm ID with ratchet fitting	70-803-0793
PTFE Encapsulated Carbon Fibre Probe 1.0mm ID	70-803-1879

For Cetac ASX 110

PFA sheathed Autosampler Probe 0.25mm ID with EzyFit	70-803-1072
PFA sheathed Autosampler Probe 0.25mm ID with UniFit	70-803-1073
PTFE Sheathed Carbon Fibre Probe 0.18mm ID with UniFit	70-803-1684
PTFE Encapsulated Carbon Fibre Probe 0.3mm ID with UniFit	70-803-1191
PTFE Encapsulated Carbon Fibre Probe 1.0mm ID	70-803-1182

For Agilent® SPS 3/SPS 4

PTFE Encapsulated Carbon Fibre Probe 0.25mm ID	70-803-0910
PTFE Encapsulated Carbon Fibre Probe 0.50mm ID	70-803-0909
PTFE Encapsulated Carbon Fibre Probe 0.75mm ID	70-803-0908
PTFE Encapsulated Carbon Fibre Probe 1.0mm ID	70-803-0853

For Agilent® I-AS

PTFE Encapsulated Carbon Fibre Probe 0.25mm ID with UniFit, 1100mm total length	60-703-1010
PTFE Encapsulated Carbon Fibre Probe 0.3mm ID with UniFit, 686 mm total length	60-703-1009
PTFE Encapsulated Carbon Fibre Probe 1.0mm ID	60-703-0533

For PerkinElmer® S10 or AS93+

PTFE Encapsulated Carbon Fibre Probe 0.25mm ID	70-803-1071
PTFE Encapsulated Carbon Fibre Probe 0.5mm ID with UniFit	70-803-0991
PTFE Encapsulated Carbon Fibre Probe 0.5mm ID	70-803-1440
PTFE Encapsulated Carbon Fibre Probe 1.0mm ID	70-803-0816

For Shimadzu®

PTFE Encapsulated Carbon Fibre Probe 0.3mm ID with UniFit, for Shimadzu® ASC-6100F/9800	70-803-1200
PTFE Coated Viton O-rings (PKT 10) With UniFit, for Shimadzu® AS10	70-803-1477